

Since
2006
TTL Loupe
&
LED Light
(Wireless)



NKvision

www.nkvision.net



CE FDA

Why NK loupe ?

 German mineral lens

 Premium lens

Building User Convenience

1. NK's frame design is lighter than flip-up type and other company's TTL loupes by ergonomically designing. and this stable frame is made of pure titanium and is coted with special plating, and cut off the source of allergy.
2. It has a wide field and depth by using mineral lenses.

Correct posture

NK Loupes help you correct your posture by guiding you to the right posture.

It provides a large view of the image to reduce eye strain. It's easier and more precise to practice.



Advantage of TTL loupe

1. TTL loupes are attached to glasses, so it has a wide visibility because they are close to the distance.
2. TTL loupes are light because they don't have PD control device.

Magnification Option (ex. Working Distance : 40cm)

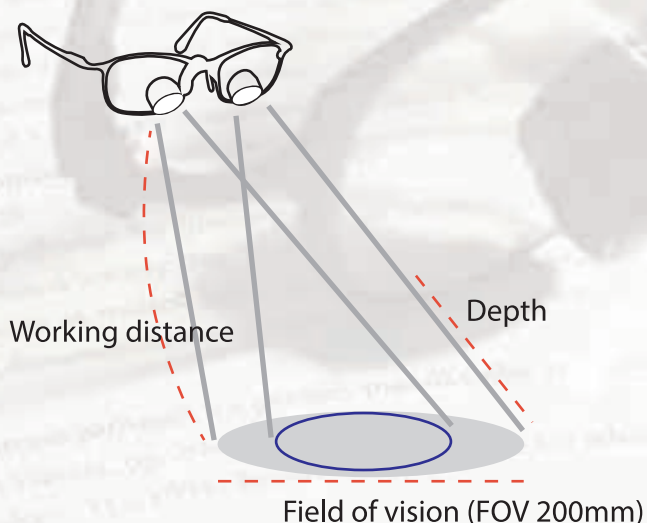

x 2.5



x 3.0



x 3.3



x 3.8



x 5.0



x 6.0





x 2.5

Style	TTL
Magnification	x2.5
Weight (g)	30
Field of view (mm)	140 @400
Resolution	More than 33 IP/mm ²
Image flatness	Less than 0.1 Diopter
Depth (mm)	200 @400

x 3.0

Style	TTL
Magnification	x3.0
Weight (g)	37
Field of view (mm)	130 @400
Resolution	More than 33 IP/mm ²
Image flatness	Less than 0.1 Diopter
Depth (mm)	110 @400

x 3.3

Style	TTL
Magnification	x3.3
Weight (g)	60
Field of view (mm)	60 @400
Resolution	More than 35 IP/mm ²
Image flatness	Less than 0.1 Diopter
Depth (mm)	50 @400

BLUE



WINE



SILVER



BLACK



NK00

SIZE 144_50_144

Style	TTL
Magnification	x2.5 / x3.0 / x3.1s / x3.3 / x3.8 / x5.0 / x6.0
Model name	NK 00
Color	Blue / Wine / Silver / Black



x 3.8

Style	TTL
Magnification	x3.8
Weight (g)	53
Field of view (mm)	70 @400
Resolution	More than 36 IP/mm ²
Image flatness	Less than 0.1 Diopter
Depth (mm)	50 @400

x 5.0

Style	TTL
Magnification	x5.0
Weight (g)	58
Field of view (mm)	60 @400
Resolution	More than 36 IP/mm ²
Image flatness	Less than 0.1 Diopter
Depth (mm)	30 @400

x 6.0

Style	TTL
Magnification	x6.0
Weight (g)	63
Field of view (mm)	45 @450
Resolution	More than 35 IP/mm ²
Image flatness	Less than 0.1 Diopter
Depth (mm)	30 @450

**RED
/BLACK**



**IVORY
/BLACK**



**GREEN
/BROWN**



**All
BLACK**



NK01 SIZE 142_48_144

Style	TTL
Magnification	x2.5 / x3.0 / x3.1s / x3.3 / x3.8 / x5.0 / x6.0
Model name	NK 01
Color	Ivory_Black / Red_Black / Green_Brown / Black



x 2.5

Style	Flip-up
Magnification	x2.5
Weight(g)	95
Field of view (mm)	120 @420
Depth (mm)	220 @420



x 3.0

Style	Flip-up
Magnification	x3.0
Weight(g)	105
Field of view (mm)	110 @420
Depth (mm)	150 @420

Flip-up x2.5 / x3.0

Style	Flip- up
Magnification	x2.5 / x3.0
Model name	NK-F
Color	Black, Blue, Red, Silver



Goggles x2.5 / x3.0

Style	Goggles
Magnification	x2.5 / x3.0
Model name	NK-G
Color	Black, Gray, Blue, Green, Red, Orange

All In One Light

Wire & Wireless

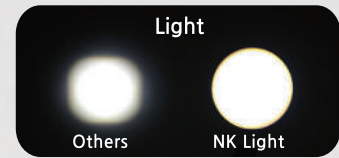

LED Light Wire & Wireless

Style	LED Light
Brightness	55,000 Lux ~ 140,000 Lux
Model name	All In One Light
Light Color	White + Yellow



UV cut-off filter



Battery Light battery

Style	Battery	Wireless Battery
Buffering hour	7~10 hr	60min ~ 100min
Charging times allowed	600 times	300 times
Color	Black	Black

Detail

This stable frame is made of pure titanium and is coated with special plating.

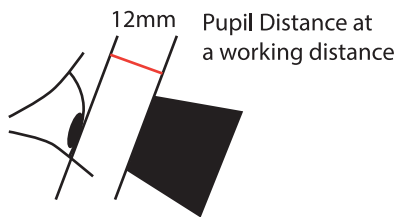
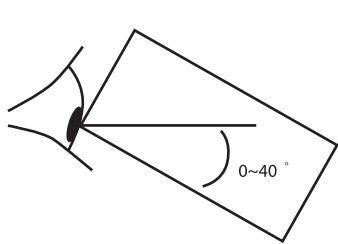
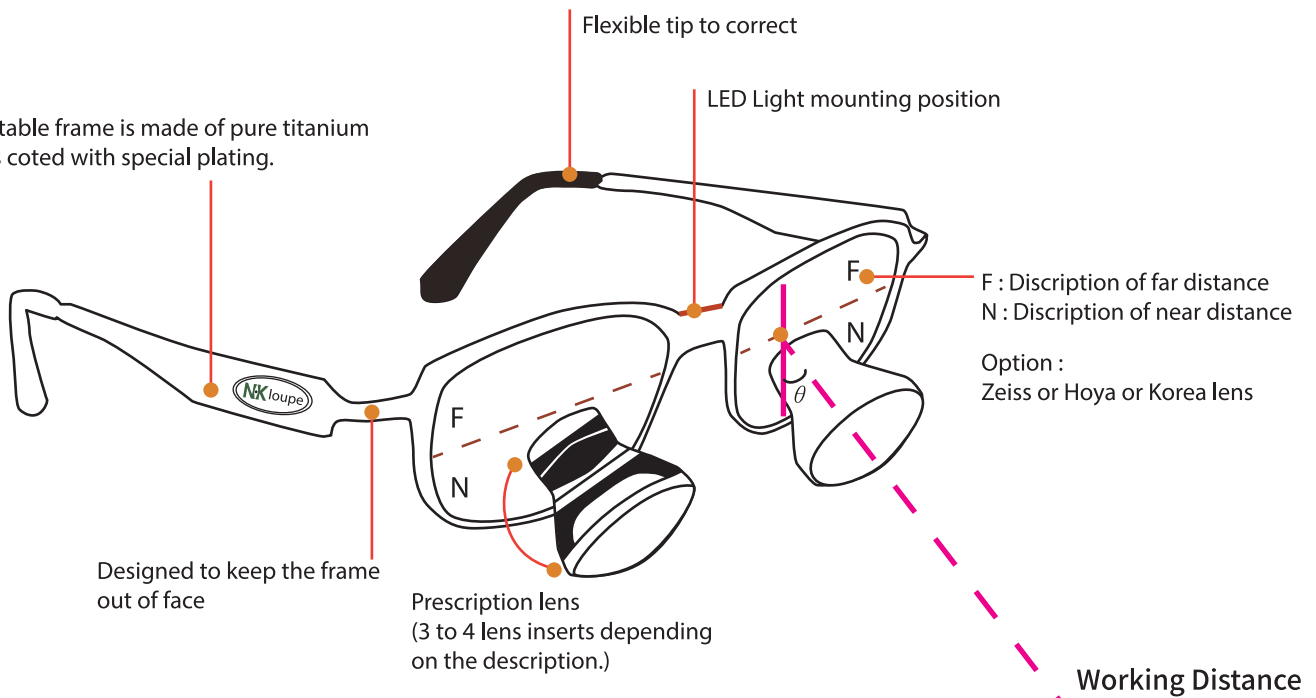

NK00

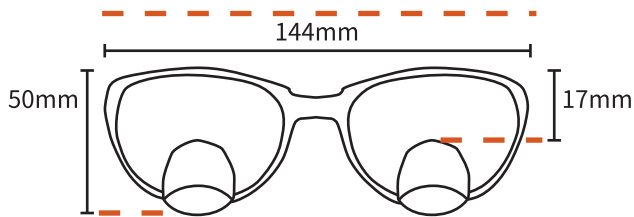

NK01

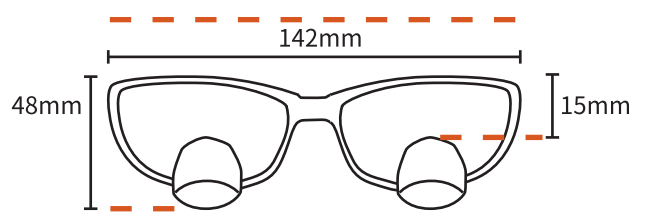

● Customized Deuch mineral lens ●

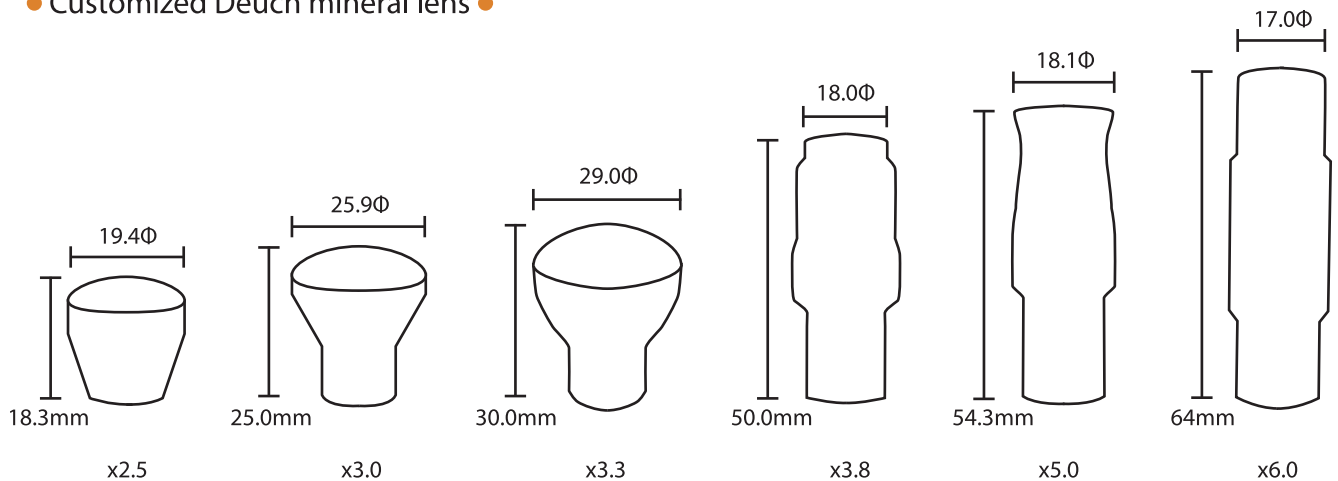



N·Kvision .inc

59, Hakjeongdong-ro, Buk-gu, Daegu, Republic of Korea

TEL.+82 - 70-4134-7257

Email. nkvision1001@gmail.com



www.nkvision.net